

Montage Typ:

2

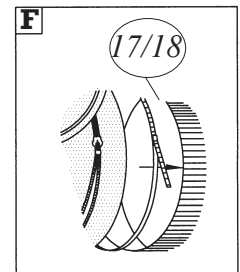

min/lfm

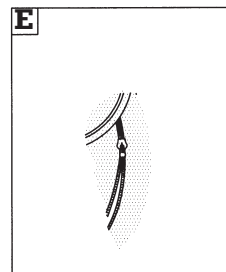
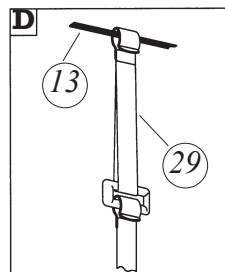
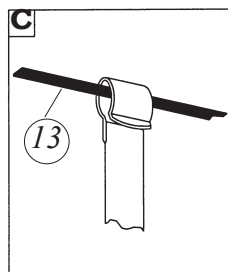
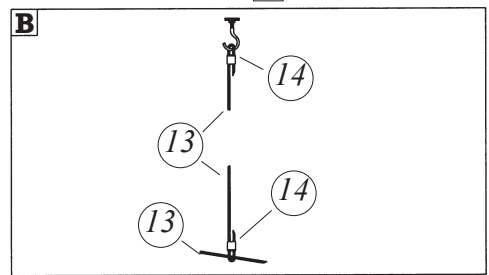
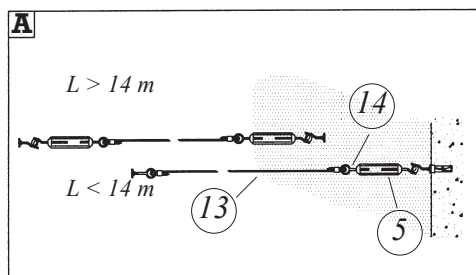
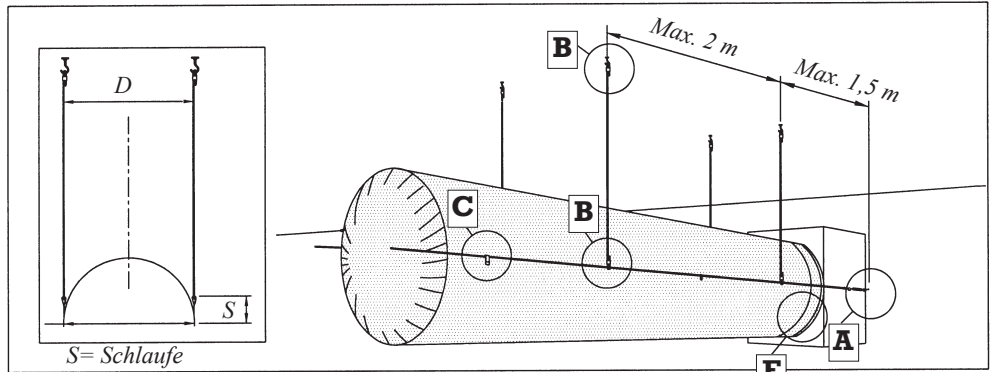
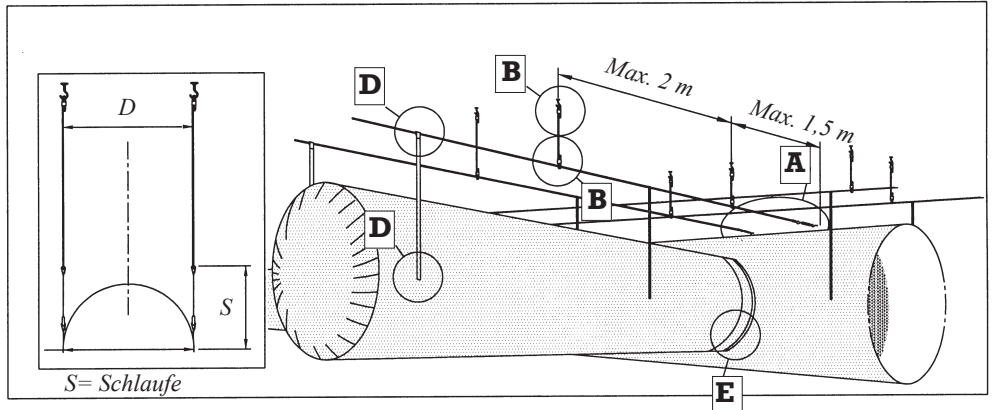

Standard



Spannschloss

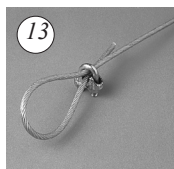

Stahldrahtseil



Drahtseilklemme



Spanngurt
No. 17 - max. dia. 500 mm



Ludhof Spanngurt
No. 18 - dia > 500 mm

FabricAir